

Type TDKRU Isolation Interlock

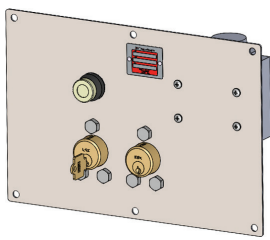

SD Series
with Coverplate

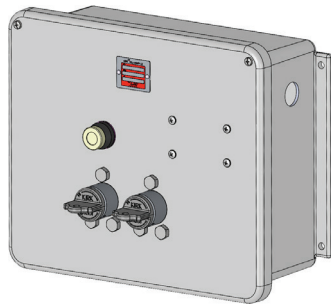

HD Series
with Housing

KIRK Type TDKRU is a time delay release unit designed to protect against hazardous energy that requires a specified amount of run-down time prior to accessing equipment. The TDKRU is a two key interlock timing device with solenoid and a signal light for indication when run-down time is complete. The TDKRU can be surface mounted with a cover plate or mounted within a housing.

OPERATION

KIRK Type TDKRU time delay unit is mechanically operated and suitable for the control of hazardous energy in which run-down is required prior to accessing equipment.

Type TDKRU key operated mechanical time delay interlock

- 1** Key B-1 (key in left cylinder) is trapped, timer is off. Power has been isolated and Key A-1 has been released from an interlock upstream in the process.



- 2** Key A-1 can be entered into the cylinder on the right on TDKRU and begin pre-set timer.



- 3** Once pre-set time has fully completed, signal light illuminates, and Key B-1 (key in left cylinder) can be released and taken to downstream interlock within the safety process. Key A-1 is now trapped.

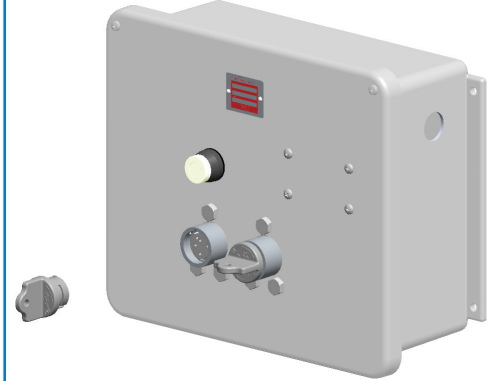



Type TDKRU Isolation Interlock



USAGE

KIRK Type TDKRU time delay units should be used within an interlock safety solution where a specified amount of time is required for run-down of equipment. KIRK TDKRU units ensure that once the run-down time has fully expired, it is now safe to continue the following safety procedures as defined by the end user's safety process and following the operations of the interlock safety solution.

 For all interlock systems to maintain system integrity, additional keys must be removed from the system and destroyed or retained by a responsible person. There should only be enough keys to operate the interlock system sequentially. Kirk Key Interlock Company will not be responsible for extra keys left in the interlock system.

 All interlocks and interlock systems must be installed by a competent and qualified person who has read and understood these instructions. Please retain this document in your technical files.

No hazardous substances were used in the manufacturing of the product. The product can be disposed of in standard waste receptacles.

INSTALLATION

The KIRK Type TDKRU units can be panel mounted with cover plate or surface mounted using a housed unit. After installation of the TDKRU, the complete interlock system should be tested sequentially by person(s) familiar with the entire system, the key sequence, and its intended purpose. Any problems or discrepancies must be corrected prior to energization.

SD series (brass) interlocks are supplied with a key in each cylinder. These keys are needed during installation of the interlocks. SD series (brass) bolt interlocks with multiple cylinders require the insertion of all keys before the lock bolt can be extended or withdrawn. Do not try to force a multiple cylinder interlock that does not have the correct keys fully inserted in every cylinder!

HD series (stainless steel) interlocks are not sold with keys. Keys must be ordered separately and may be required during the installation process.

 For all interlock systems to maintain system integrity, additional keys must be removed from the system and destroyed or retained by a responsible person. There should only be enough keys to operate the interlock system sequentially. Kirk Key Interlock Company will not be responsible for extra keys left in the interlock system.

 All interlocks and interlock systems must be installed by a competent and qualified person who has read and understood these instructions. Please retain this document in your technical files.

MAINTENANCE

Kirk key interlocks should be periodically lubricated with a small amount of dry powder graphite. DO NOT use oil or grease of any type as these will collect dirt and impede the proper operation of the lock cylinder.

SD SERIES: Apply a small amount of graphite to the key and insert the key into the lock cylinder. Work the key in and out and turn the key several times in order to distribute the graphite inside the lock cylinder.

HD SERIES: Apply a small amount of graphite behind the inner turn shaft. Insert and turn the key a few times in order to distribute the graphite below the lock cylinder.

KIRK offers a Graphite Lubrication kit (part# GL-1) complete with instructions for use.

Protective covers for most products are also available as accessories. Covers can be utilized to protect the lock cylinders when located outdoors or in a demanding environment.

Type TDKRU Isolation Interlock



TECHNICAL DATA

Type TDKRU	SD Series	HD Series
Cylinder Housing	Brass	Electropolished 316 SS
Plug/Inner Turn Shaft	Brass	Electropolished 316 SS
Key Material	Nickel-Silver	Electropolished 316 SS
Key Style	7-Pin Tumbler	Dowel Pin
Type of Mounting	Panel or surface mounted with optional enclosure	
Temperature Ratings	-13F to 100F	-13F to 100F
Weight - Housed TDKRU	16 lbs	16 lbs

* Weight of TDKRU unit based on product with one key, no accessories or mounting hardware

APPLICATION

The Type TDKRU units are used as part of safety systems suitable for hazardous energy that requires a specified run-down time before safely accessing equipment.

An example of an interlock safety solution implementing a TDKRU unit is scheme 38 from the KIRK scheme book. This application prevents the closing of ground switch B under load and to enable access to the capacitor bank enclosure only after the capacitor bank has been grounded and discharged.

Initial system status: Ground switch B is locked open. All capacitor bank enclosure doors are locked closed. Key A-1 is held in L-O interlock on breaker A. Key A-2 is held in the TDKRU unit. Key A-3 is held in L-C interlock on ground switch B. Key A-4 is held in L-C interlock on access door #1.

To gain access to capacitor bank enclosure, proceed as follows:

1. Open breaker A.
2. Turn key A-1 in L-O interlock on breaker A to lock open. Key A-1 is now free.
3. Insert Key A-1 in initiating lock on TDKRU. Turn key to start time delay action.
4. Signal light energized and key A-2 can be removed after the prescribed time period. Key A-1 is now held.
5. Insert key A-2 in L-O interlock on ground switch B and turn to unlock. Close ground switch B. Key A-2 is now held.
6. Turn key A-3 in L-C interlock on ground switch B to lock closed. Key A-3 is now free.
7. Insert key A-3 in L-C interlock (Type M2D) on capacitor bank enclosure access door #1 and turn to unlock. Key A-3 is now held and key A-4 is now free.
8. Open access door #1 to enter capacitor bank enclosure.
9. Insert key A-4 in L-C interlock (Type D) on access door #2 and turn to unlock. Key A-4 is now held.
10. Open access door #2 to enter capacitor bank enclosure.

Reverse sequence to restore service.

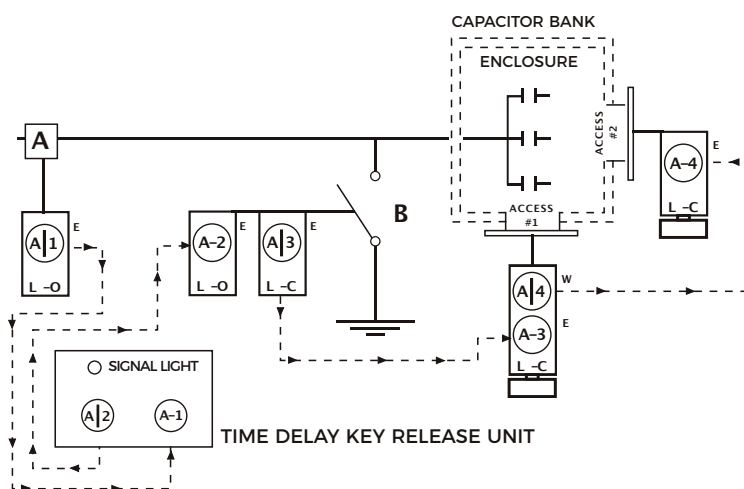

Capacitor bank scheme with time delay.

Type TDKRU Isolation Interlock



DRAWING

Dimensions: in inches

SD Series Type TDKRU

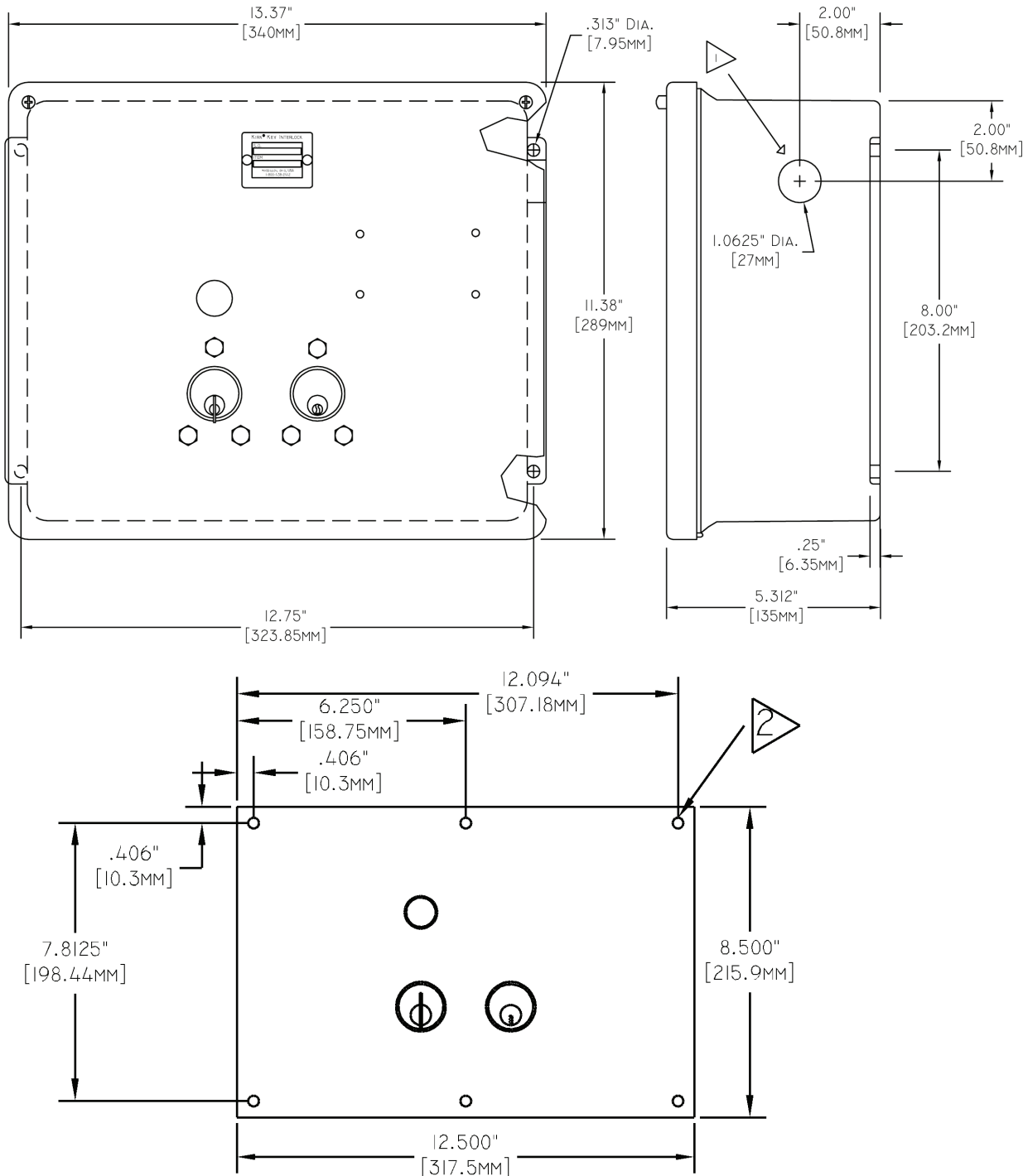

NOTES:

- 1) 1.063" (27mm) diameter clearance hole.
- 2) Six .312 (7.94mm) diameter holes for mounting "Coverplate Only" model (6 holes).

Type TDKRU Isolation Interlock



DRAWING

Dimensions: in inches

HD Series Type TDKRU

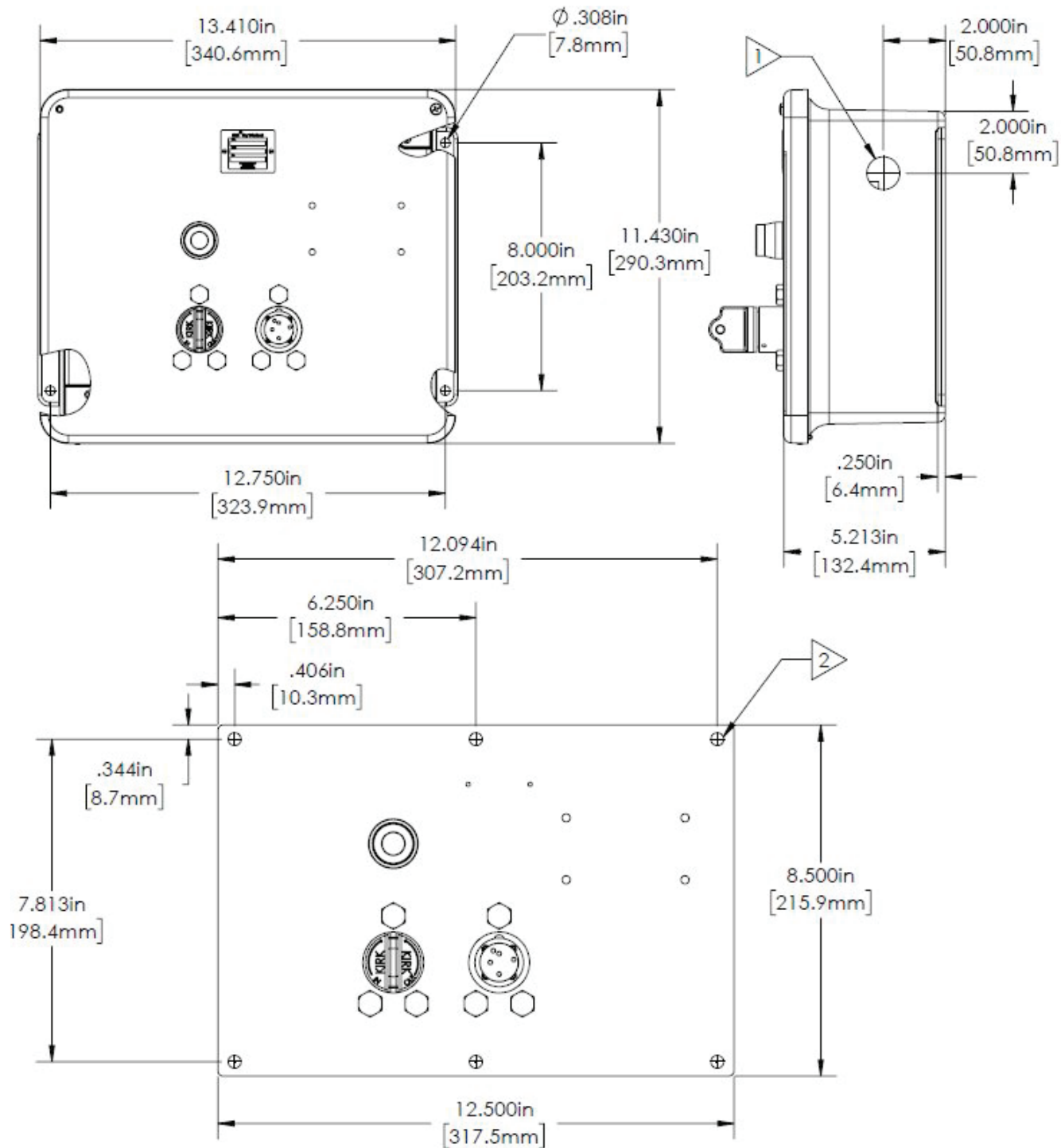

NOTES:

- 1) 1.063" (27mm) diameter clearance hole.
- 2) Six .312 (7.94mm) diameter holes for mounting "Coverplate Only" model (6 holes).

Type TDKRU Isolation Interlock



ORDER INFORMATION

	0	1	2	3	4	5	6	7	8	9	10
Part number		T	D	K	R	U					

0	Series	K = SD Series (brass)		S = HD Series (stainless)	
6	Mounting Style	2 = Housed	4 = Cover Plate Only		
7	Solenoid Voltage	1 = 120VAC	2 = 24VDC	3 = 125VDC	4 = 48VDC
8	Time Delay	1 = 1-300 seconds		2 = 3-300 minutes	
9	Stamp Key Interchange	- = No S = Yes		Stamp Key interchange only available for HD series when protective Flip Open Cover is added	
10	Protective Covers see protective covers data sheet	- = No	C = Push On	F = Flip Open	- = No F = Flip Open with LOTO provision

CONTACT INFORMATION

The Kirk Key Interlock Company LLC

9048 Meridian Circle NW North Canton, OH 44720, USA

Toll Free: +1 800-438-2442 O: +1 234-209-9301 F: +1 330-497-4400

Quotes & Inquiries sales@kirkkey.com PO Submission & Orders orders@kirkkey.com